



Backhoe Manhole and Trench Boxes



Important Notes

All excavation work must be thoroughly planned before work commences on site to identify hazards and assess risk.

These instructions form guidance for Backhoe Manhole and Trench Boxes. Non-standard applications should be approved by a suitably qualified engineer.

Ensure all personnel engaged in excavation operations are properly briefed and adequately supervised by a competent person.

THIS USER GUIDE IS NOT CONTROLLED WHEN PRINTED

To ensure you are reading the most up-to-date version of this user guide, [download as a pdf](#) from the Groundforce Technical Library.

**IF IN ANY DOUBT SEEK FURTHER ADVICE:
ON FREEPHONE - 0800 000 345**



Certification Number 14419
ISO 9001 • ISO 14001 • ISO 45001

Rev	Date	Comments	Initial
1.7	16/05/23	Equipment specifications updated for consistency with Technical File	DSW





Groundforce, Central House,
Beckwith Knowle, Otley Road,
Harrogate, HG3 1UD



T: 0800 000 345

E: info@vpgroundforce.com

SAFETY

Common Symbols and Meanings

PERSONAL PROTECTIVE EQUIPMENT (PPE)	
	Use eye protection
	Use hearing protection
	Wear protective gloves
	Wear head protection
	Wear protective footwear

WARNING SYMBOLS	
	General warning
	Crushing of hands

Introduction

The Backhoe Box range has been developed to meet the needs of the contractor when using a smaller 180° backhoe excavator. With minimum weights of 645kg for the trench version, and 960kg for the 2.5m manhole version, most small excavators can handle these boxes. All boxes are capable of supporting trenches up to 4m deep when a base module is connected to two top extension units.

Backhoe Manhole and Trench boxes are lightweight units with their own dedicated strutting system to help minimise weight. Fixed length and incrementally adjustable struts are available: fixed length struts are generally used for Manhole Boxes to form a square box configuration whereas adjustable struts are typically used with Trench Boxes to allow for width adjustment on-site.

Equipment Identification



Equipment Specification

Specification	Backhoe Box Type				
	Trench Box	2.0m Manhole	2.5m Manhole	3.0m Manhole	3.5m Manhole
Plate Length (m)	2.85	2.0	2.5	3.0	3.5
Plate Height (m)	2.0 (base) 1.0 (top)	2.0 (base) 1.0 (top)			
Plate Thickness (mm)	63	60			
Weight of Individual Plates (kg)	344 (base) 174 (top)	420 (base) 220 (top)	427 (base) 225 (top)	487 (base) 280 (top)	570 (base) 327 (top)
Typical Box Weight (kg)	694 (base)* 387 (top)*	914 (base)** 477 (top)**	965 (base)** 506 (top)**	1128 (base)** 637 (top)**	1294 (base)** 730 (top)**
Maximum Trench Depth (m) ^[1]	4				
Internal Width Between Plates (m)	0.3 - 2.1	1.35 - 1.88	1.35 - 2.38	1.35 - 2.88	1.35 - 3.38
External Width (m)	0.43 - 2.23	1.47 - 2.0	1.47 - 2.5	1.47 - 3.0	1.47 - 3.5
Clearance Below Strut (m)	1.215	1.18			
Clearance Between Struts (m)	2.55	1.8	2.3	2.8	3.3
Strut length to achieve a "square" box (mm) -	N/A	850	1280	1780	2280

* Typical value, the weight will vary with strut configuration supplied

** Weights for "Square" set up. Other widths are possible if trench box struts are used.

Assembly Instructions



Safety Notes

Maintain a means of safe access at all stages for the provision of contractor risk assessments. The end-user has a responsibility under LOLER to ensure that all lifting equipment is suitable and fit for use including appropriate and valid certification. [See separate Groundforce Chain Sling user guide.](#) Avoid the trapping of fingers at all stages of work



BOX ASSEMBLY (applies to Trench and Manhole Boxes)

- Using a certified sling connected to the four corner lifting points, place both box plates on firm, level ground, one facing up and one facing down.
- Place all four struts onto the bosses protruding from the panel facing upwards and secure them using the 20mm pin and retaining clip supplied.
- Reconnect the sling to the lifting points of the panel facing downwards and lift it into position above the struts.
- Lower the plate carefully, guiding the bosses into the ends of the upstanding struts.
- Secure the struts to the panel with the remaining 4 pins and retaining clips.
- Disconnect the lifting sling legs from the two lower lifting points, and lift the box to the upright working position.

Note: when not in use, it is essential that the boxes are stored on flat stable ground. If in doubt, they should be dug into the ground by at least 0.5m or stored flat on their side.

- Connect the two free legs of the lifting sling to the upper lifting points of the other panel before lifting the box into the trench.

Note: Top extension boxes are assembled in the same way, but with only two struts fitted.

Connection Details and Width Ranges

Strut Length "L" (mm)	Strut Weight (kg)	External Trench Box width (mm)	External Manhole Box width (mm)
250	5.4	430	1470
375	8.1	555	1595
550	11.5	730	1770
700	15.1	880	1920
850	18.3	1030	2070
1150	24.8	1330	2370
1280	27.6	1460	2500
1780	38.4	1960	3000
Connector	15.4	See chart	N/A

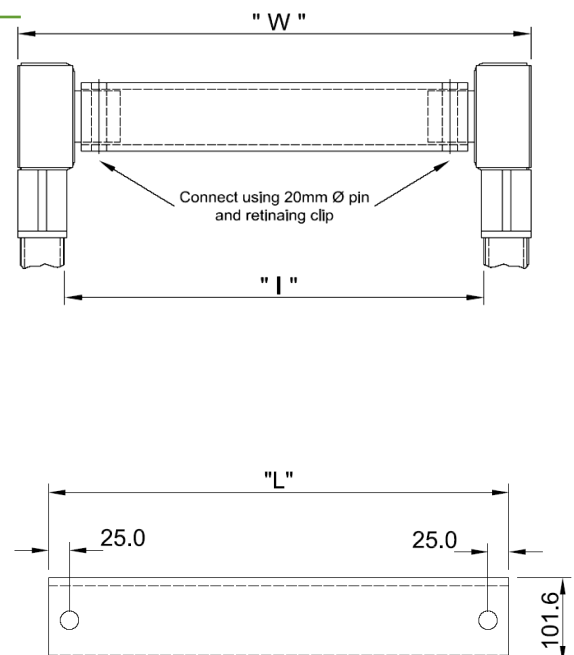

Connection Details and Width Ranges (cont...)

The range of widths available can be increased by the use of the Strut Connector shown below. This allows the standard struts to be used in pairs in three combinations as shown below right. The assembled arrangement for the minimum configuration is shown below left; the table shows the box dimensions for all possible combinations.

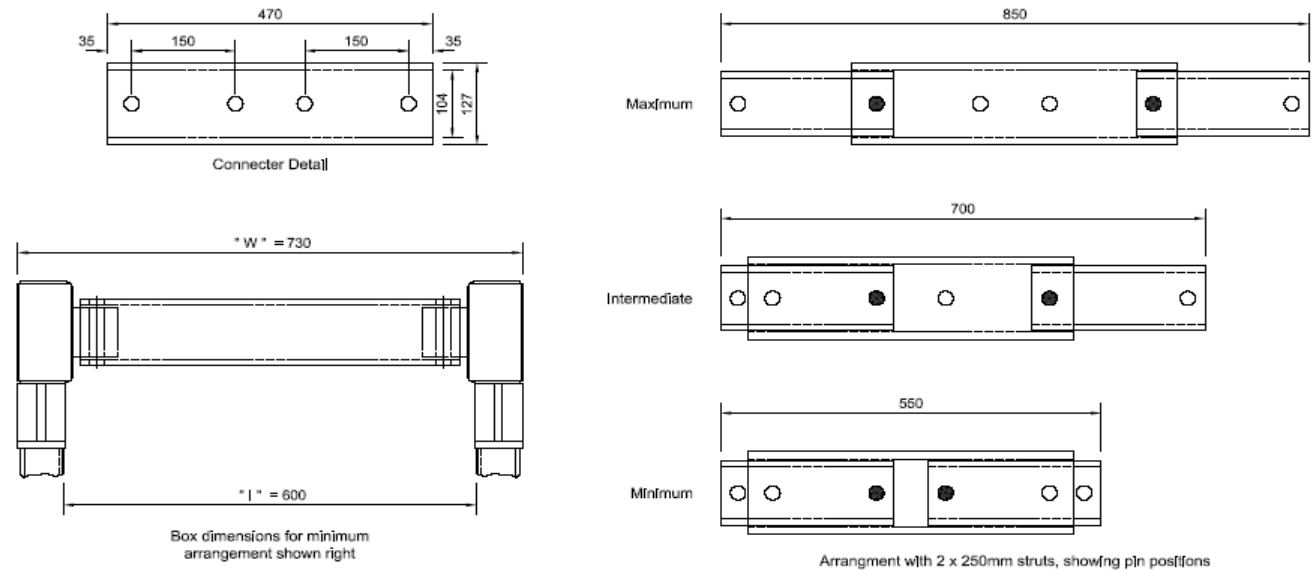

Strut 1	Strut 2	Internal Dimension "I" (mm)			External Dimension "W" (mm)		
		Configuration			Configuration		
		Minimum	Intermediate	Maximum	Minimum	Intermediate	Maximum
250	250	600	750	900	730	880	1030
	375	725	875	1025	855	1005	1155
	425	775	925	1075	905	1055	1205
	550	900	1050	1200	1030	1180	1330
	700	1050	1200	1350	1180	1330	1480
	850	1200	1350	1500	1330	1480	1630
375	375	850	1000	1150	980	1130	1280
	425	900	1050	1200	1030	1180	1330
	550	1025	1175	1325	1155	1305	1455
	700	1175	1325	1475	1305	1480	1630
	850	1375	1525	1675	1505	1655	1805
425	425	950	1100	1250	1080	1230	1380
	550	1075	1225	1375	1205	1355	1505
	700	1225	1375	1525	1355	1505	1655
	850	1350	1500	1650	1480	1630	1780
550	550	1200	1350	1500	1330	1455	1605
	700	1350	1500	1650	1480	1630	1780
	850	1500	1650	1800	1630	1780	1930
700	700	1500	1650	1800	1630	1780	1930
	850	1650	1800	1950	1780	1930	2080
850*	850*	1800	1950	2100	1930	2080	2230

*Struts above 850mm should not be used with the connector

Installation Procedures

Safety Notes

It is recommended that the box panels extend over the full height of the dig and not be “flown” above the base of the excavation unless both the following conditions are met. a) The box is adequately supported and b) has been approved as a safe method of work by a risk assessment undertaken by a competent person.

Always use a secured ladder to enter or exit the box - never enter an unsupported trench.

After the ground has been excavated to approx. 1m or deeper as ground conditions permits, the box is lowered into the trench using a 4-leg chain sling of the correct capacity. **Note:** Do not enter an unsupported excavation.

The excavator driver then progressively digs between the two faces of the box plates and pushes down on each of the four corners of the box in turn using the back of the machine bucket.

Note: The difference in height between panel corners must not exceed 150mm during this operation otherwise damage to the box may occur.

This method continues until the desired depth is reached. Where top extensions are used, these should be attached to the base using the connectors supplied at each corner. This should be done when the top of the base is approximately 200mm above ground level. Each connector is secured using a pair of pins and retaining clips.

Extraction

Extraction of the units is simply a reverse of the process; back filling the trench and then progressively pulling the box upwards using the chain sling. If top extensions have been used, these should be disconnected as the joint becomes clear of the ground, and then lifted clear before reconnecting the sling and continuing the extraction.

Note: Never snatch at the chain during removal of the box whilst using the four-leg chain. If the box becomes stuck, seek further advice from Groundforce

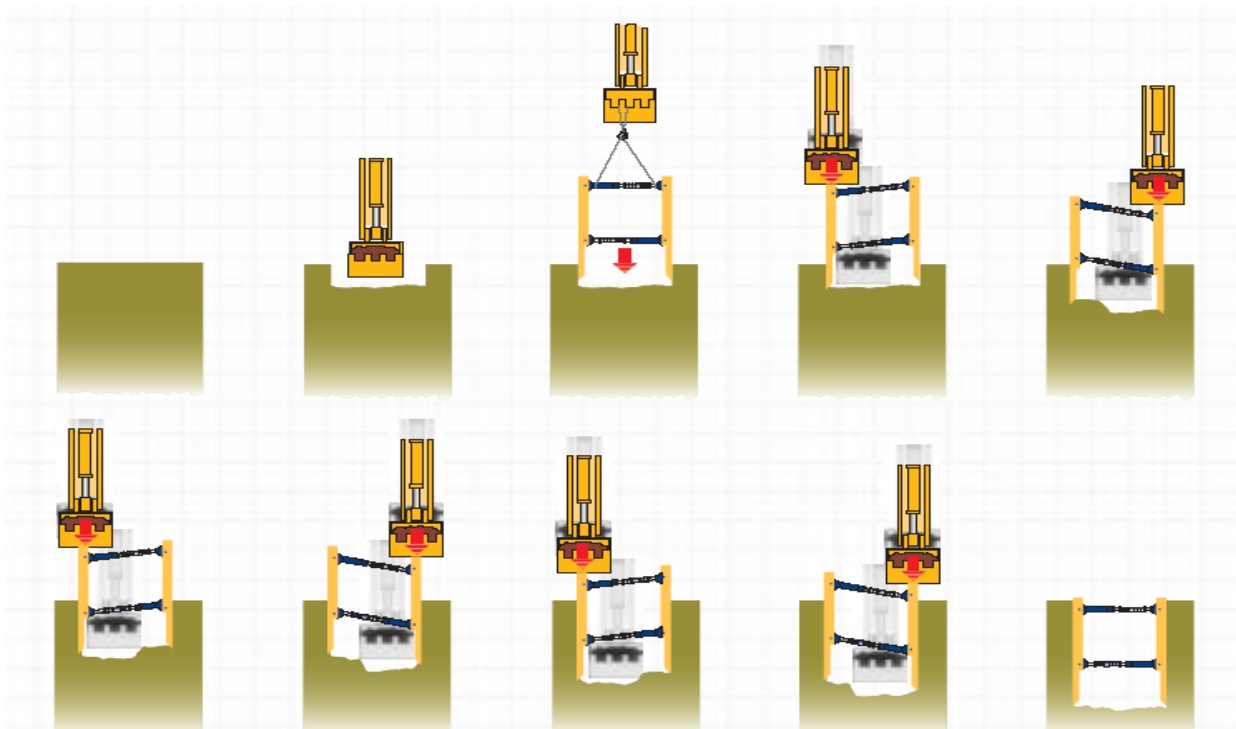



Do	Do Not
<ul style="list-style-type: none">✓ Inspect all components at the start of every shift✓ Assess weights correctly and use appropriately certified lifting equipment✓ Toe-out base boxes by 50mm✓ Provide support over the full height of the dig✓ Ensure all pins and clips are correctly fitted✓ Use four panel connectors for upper box attachment✓ Use only lifting points for chain attachment✓ Provide edge protection or handrail panels✓ Push the plates at the corner positions only✓ Keep personnel clear of excavator slewing zone✓ Always use a banksman✓ Locate underground services before excavating✓ Lay box flat before dismantling✓ Store assembled boxes on firm, level ground only or lay flat on their sides✓ Take care to avoid trapping fingers	<ul style="list-style-type: none">✗ Exit the box into an unsupported area✗ Push plates down by more than 150mm at a time✗ Snatch the chain during removal✗ Climb on the struts – always use a secured ladder✗ Hang/store materials on the struts✗ Excessively force the box into the ground✗ Allow personnel in the box during installation✗ Accidentally strike the struts✗ Drag the box by any means✗ Use more than four extension bars per strut✗ Use more than two top extension boxes unless specified by Groundforce✗ Load the struts laterally or vertically✗ Fly the boxes above the base of the excavation unless approved by a competent person



Appreciation of Excavation Safety

The theoretical safety course is mapped to both EUSR and the National Occupational Standards and introduces the learner to the basics of working around excavations. Designed as an awareness course, particular emphasis is provided to key aspects of managing and/or overseeing excavation work. [Visit the course page](#) for more details.

The one day course can accommodate up to 20 delegates per day

EXCAVATION TRAINING AVAILABLE

Train your team with **Groundforce Training Services**

• Nationwide training locations • EUSR accredited • Flexible courses

☎ 0800 023 2663